

HG-20000SB

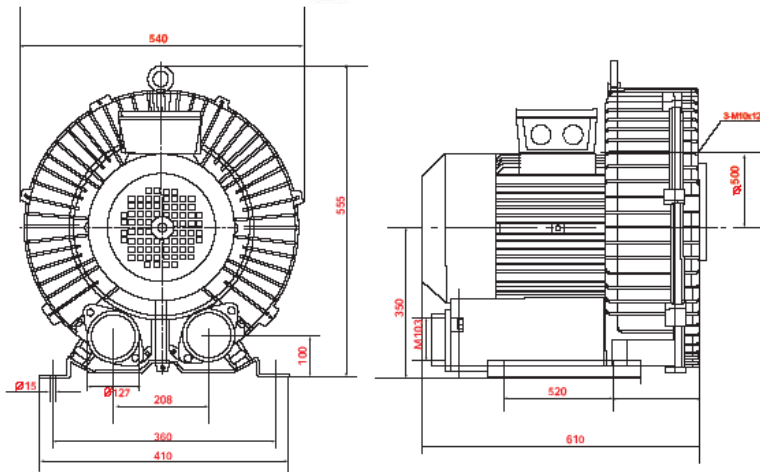

POSITION OF BEARING (FRONT MODEL): MIDDLE 6308 (BEARING MODEL); BACK 6308 (BEARING MODEL)

HG系列旋涡气泵性能曲线
(仅供参考不作检测依据)

the technology parameter of the HG series vortex gas pump
(only for reference,not for test gist)

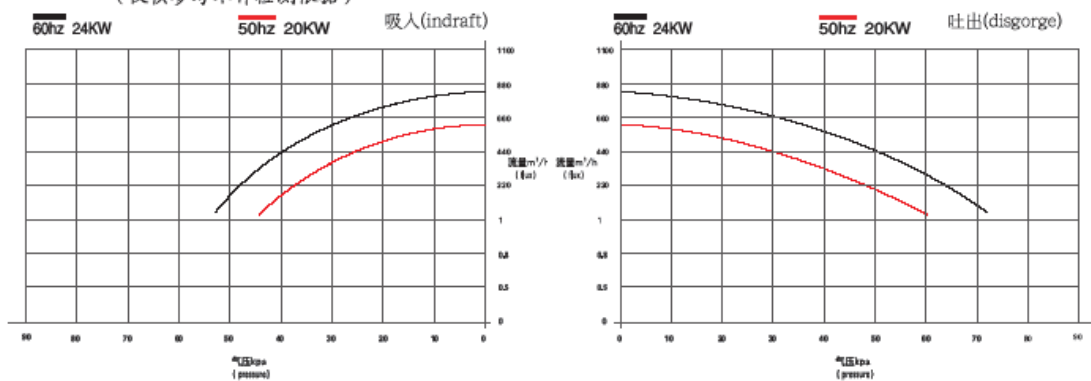

When ordering please indicate voltage and periodicity (any voltage are also ok)

Type	Voltage V	Current A	Frequency Hz	Max. air pressure kPa	Max. flux m ³ /h	Max. vacuum degree -kPa	Power kW	Rotary speed r/min	Noise dB(A)	N.W. kg	G.W. kg	box up volumn cm ³
HG-20000SB	Δ380	39.3(47.2)	50(60)	60(72)	630(756)	44(53)	20 (24)	2800 (3400)	<70	195	213	82×70×80

The data are only for reference in the form the factory does not issue a separate notice to data modification